

**NV Bend**

Ventilation system bend, consists of rolled sectors.  $r=1*d$ .

**NV 90°**

Nominal size d	l mm	l <sub>p</sub> mm	Weight kg
250	250	50	1,7
315	315	50	3,6
400	400	50	6,9
500	500	61	10,1
630	630	61	15,0
800	800	96	27,0
1000	1000	110	47,0
1250	1250	110	64,0
1600	1600	110	116,0

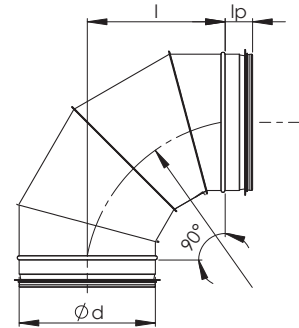

**NV 60°**

Nominal size d	l mm	l <sub>p</sub> mm	Weight kg
250	146	50	2,2
315	184	50	3,0
400	234	50	4,6
500	292	61	6,1
630	367	61	9,3
800	466	96	15,6
1000	583	110	29,0
1250	728	110	36,0
1600	932	110	83,0

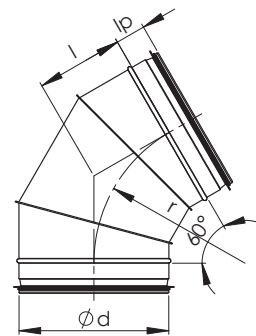

**NV 45°**

Nominal size d	l mm	l <sub>p</sub> mm	Weight kg
250	105	50	1,1
315	130	50	2,2
400	165	50	3,7
500	205	61	5,1
630	260	61	7,7
800	330	96	15,0
1000	415	110	24,0
1250	520	110	34,0
1600	665	110	63,0

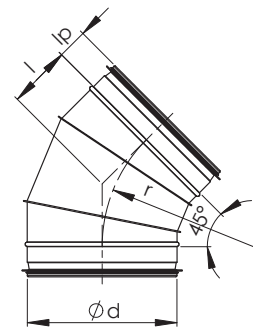

**NV 30°**

Nominal size d	l mm	l <sub>p</sub> mm	Weight kg
250	70	50	0,8
315	85	50	1,7
400	110	50	3,4
500	135	61	3,7
630	170	61	5,6
800	215	96	11,0
1000	270	110	17,0
1250	335	110	26,0

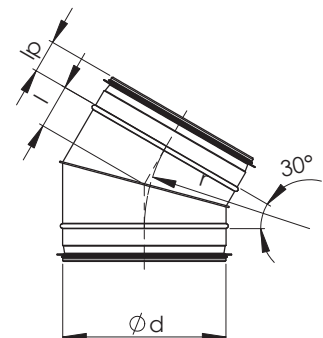

**NV 15°**

Nominal size d	l mm	l <sub>p</sub> mm	Weight kg
250	33	50	0,75
315	51	50	1,1
400	53	50	1,9
500	66	61	2,4
630	83	61	3,3
800	105	96	7,5
1000	132	110	13,0
1250	165	110	17,0

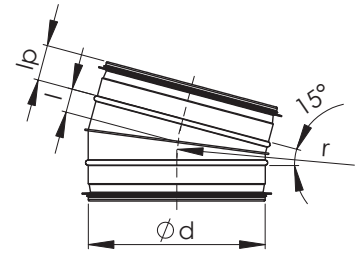
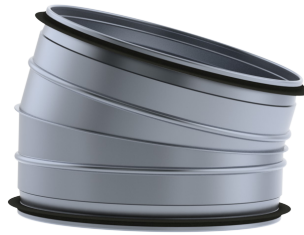

**Product codes**

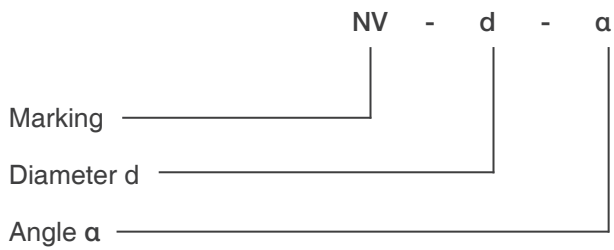

Example: NV 315-90